

We DEVELOP

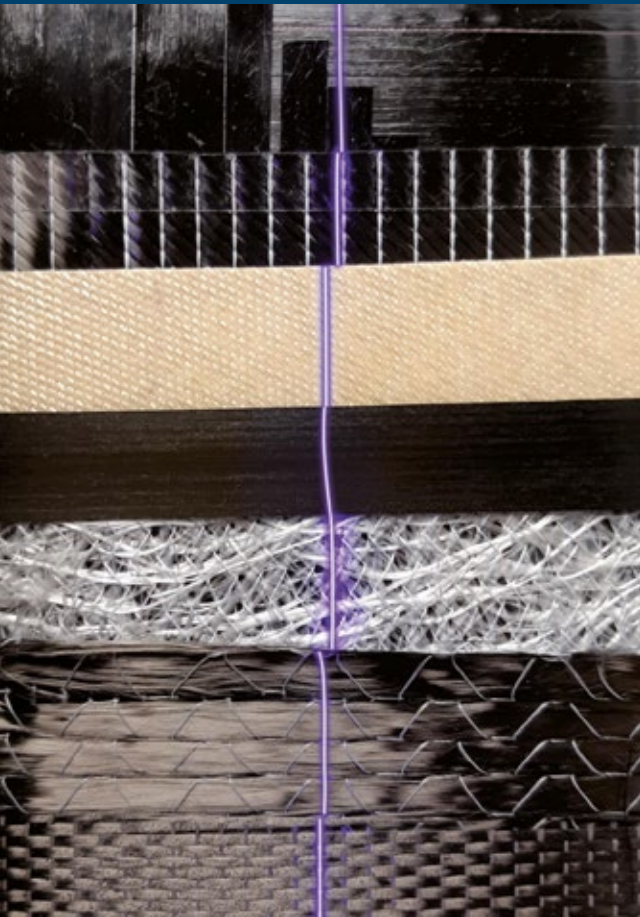

PF INSPECT

Inspection and measurement solution for your composite processes

Main advantages

- In-line inspection, or ply by ply
- Detection and location of defects with a size above 0.1 mm
- Non-contact detection
- Rapid and easy integration to the production tool
- Simple to use, easy to configure
- In-line inspection before, during and after composite material deposition, ply after ply
- Possible measurements on a wide variety of composites

Benefits

- In-line inspection of 100% of production
- Productivity gains 20% to 30% compared to standard methods for inspection
- Traceability and real time documentation tool
- Process performance analysis and production optimisation
- Quality control

Applications

- Measuring and locating the direction of the fibre
- Locating the position of each preform
- Inspection of surface quality

The sensors are built into the weaving, non-weaving, braiding and prepreg machines so as to inspect on the fly.

Depending on the configuration of the machine, both sides of the material can be inspected.

In-line detection of:

- Weaving defects
- Missing fibre
- Fold defects
- Missing elements, pulling
- Texture inclusions
- Deburring, delaminating defects

Industries:

- Automotive
- Wind energy
- Aerospace
- Marine

We
DEVELOP

PF INSPECT

Inspection and measurement solution for your composite processes

On-the-fly inspection of unprocessed material

Technical specifications

Fibre orientation: $\pm 0,1^\circ$

Inspection speed: up to 2 metres/second

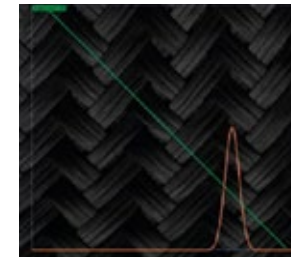
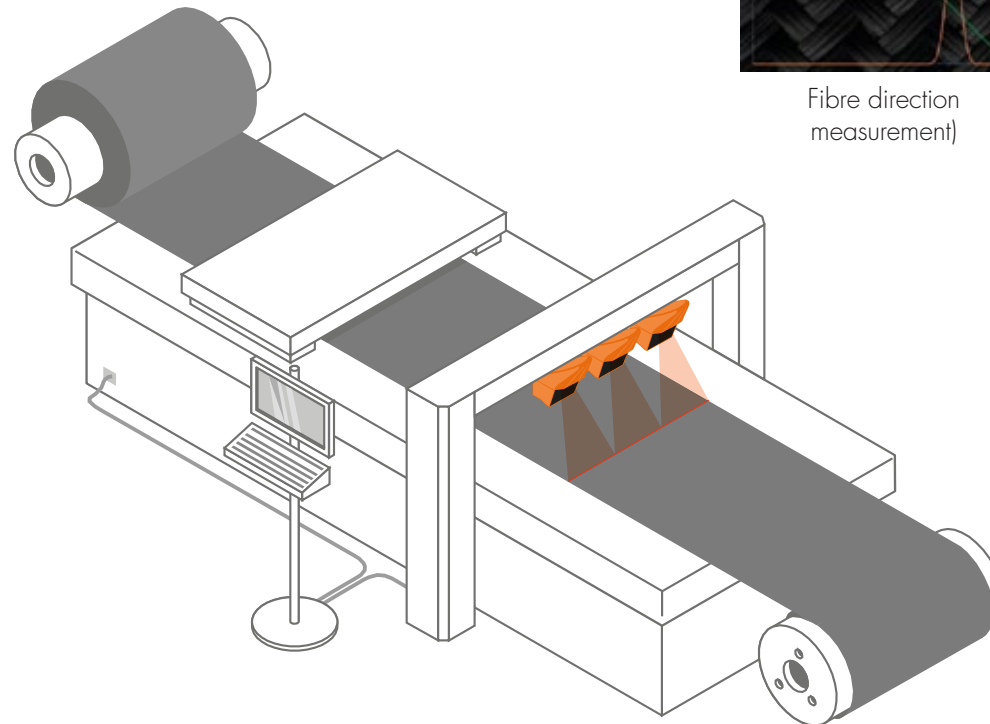

Fibre direction
measurement)

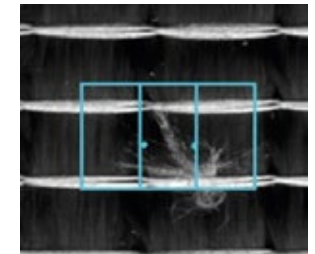

Foreign bodies
detection



Missing seam

PF INSPECT

Inspection and measurement solution for your composite processes

Inspection of the material for each placement of preforms

Technical specifications

Fibre orientation: $\pm 0,1^\circ$

Fold detection from 0.1 mm (thickness)

Location: 1/10 mm

Inspection speed: up to 2 metres/second

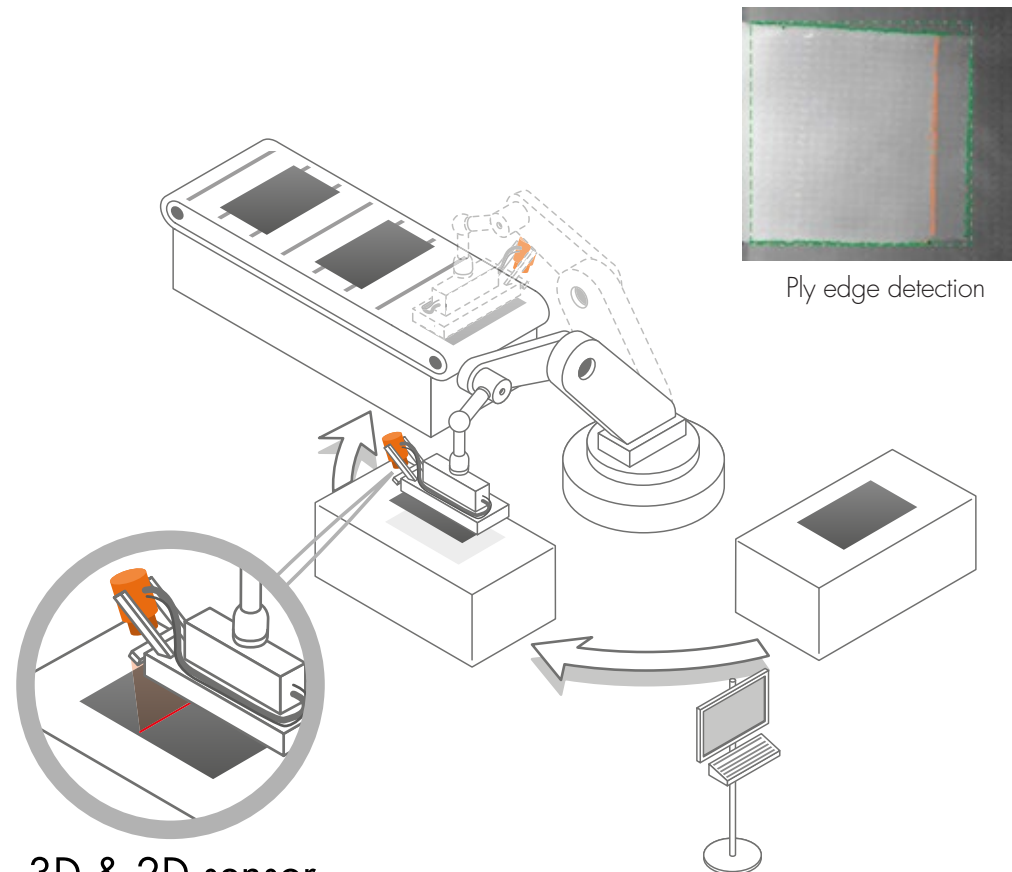

3D & 2D sensor

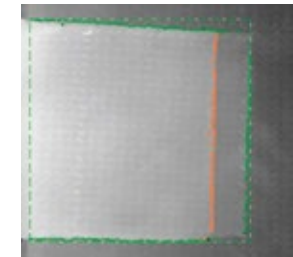

Ply edge detection

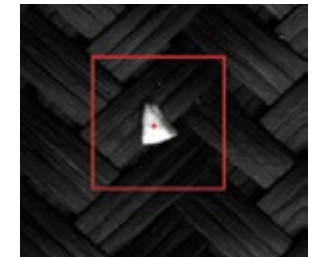

Foreign bodies
detection

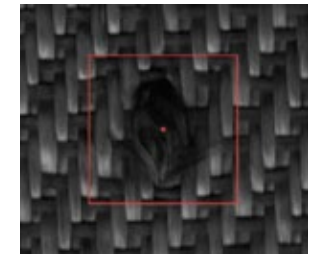

Fuzz detection